

LED FLOOD LIGHT



The ATLAS LED Floodlight by Beyond LED Technology is designed to deliver high-performance, energy-efficient lighting for a wide range of applications, from driveways and yards to signage and security. With adjustable CCT, it offers flexibility and precision in lighting, allowing you to tailor the illumination to suit any environment. Featuring up to 136 lumens per watt, this floodlight provides excellent brightness with minimal energy consumption. The 150° beam angle ensures broad coverage, while the aluminum construction guarantees durability. Designed for easy installation with a U-Bracket mount, the ATLAS is perfect for both residential and commercial use.

Product Features

- Up to 136 lm/W
- 50 Watt & 80 Watt
- Adjustable CCT
- 0-10V Dimmable
- 150° Beam Angle
- U-Bracket Included
- Bronze Housing
- Input voltage 120-277VAC
- UL & DLC listed
- 5-year warranty

LED FLOOD LIGHT

WATT	MAX LUMENS	ADJ. CCT	INPUT VOLTAGE	CRI	LIGHT SPREAD	CONSTRUCTION	DIMMING	IP RATING	CERTIFICATIONS
50W	6800	3K/4K/5K	120-277V	>80	150°	Die-cast Aluminum+PC	0-10V	IP65	UL & DLC
80W	10880	3K/4K/5K	120-277V	>80	150°	Die-cast Aluminum+PC	0-10V	IP65	UL & DLC

Specifications

Parameter	Description	Value
General Performance	Model #.	BLT-FL06E-50WBH8DA1-BRFM30/40/50
	Watt	50W
	Max Lumens	6800
	Lumen Efficacy	Up to 136LM/W
	Color Temperature	3000K / 4000K / 5000K
	CRI (Ra)	>80
	Light Spread	150o
	Input Voltage	120-277Vac
	Frequency	50/60Hz
Electrical	Optional Accessory	Surge protector
	PF (Tolerance: -3%)	≥0.9
	THD (Tolerance : +5%)	≤20%
	Driver Model	Beyond Driver
	Driver Surge protection	L/N-PE: 2.5kV, L-N: 2.5kV
	Operating Temperature	-30°C to 45°C
	Storage Temperature	-40°C to 80°C
	Operating Humidity	20% - 90% RH
Physical	Storage Humidity	20%-95%RH
	LED Brand	Lumileds
	LED Type	SMD2835
	LED QTY	80 PCS*2
Qualification	Construction	Die-cast aluminum
	Housing Color	Bronze
	IP Rating	IP65
	Warranty	5 Year

LED FLOOD LIGHT

Specifications

Parameter	Description	Value
General Performance	Model #.	BLT-FL06E-80WBH8DA1-BRFM30/40/50
	Watt	80W
	Max Lumens	10880
	Lumen Efficacy	Up to 136LM/W
	Color Temperature	3000K / 4000K / 5000K
	CRI (Ra)	>80
	Light Spread	150o
	Input Voltage	120-277Vac
	Frequency	50/60Hz
Electrical	Optional Accessory	Surge protector
	PF (Tolerance: -3%)	≥0.9
	THD (Tolerance : +5%)	≤20%
	Driver Model	Beyond Driver
	Driver Surge protection	L/N-PE: 2.5kV, L-N: 2.5kV
	Operating Temperature	-30°C to 45°C
	Storage Temperature	-40°C to 80°C
	Operating Humidity	20% - 90% RH
Physical	Storage Humidity	20% - 95% RH
	LED Brand	Lumileds
	LED Type	SMD2835
	LED QTY	128PCS*2
Qualification	Construction	Die-cast aluminum
	Housing Color	Bronze
	IP Rating	IP65
	Warranty	5 Year

LED FLOOD LIGHT

Correlated Color Temperature (CCT)

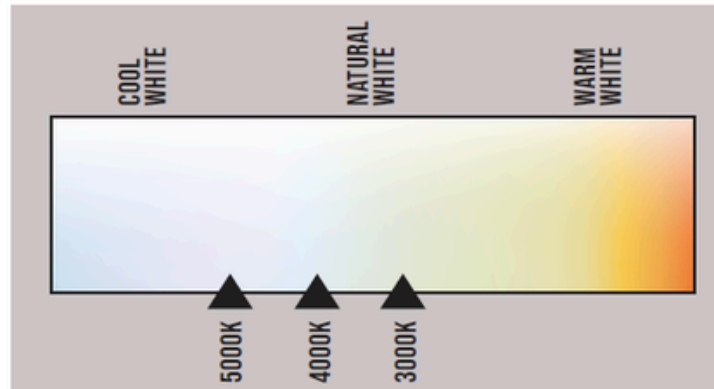

Adjustable CCT Button: 3000K/4000K/5000K



Dimensions

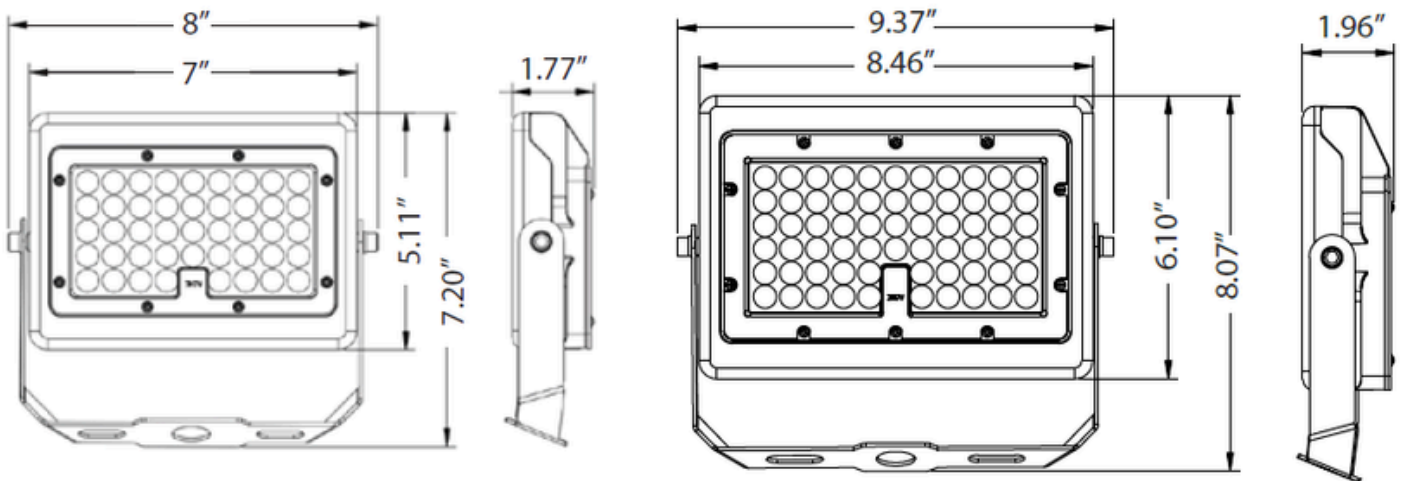

LED FLOOD LIGHT

Photometric Data

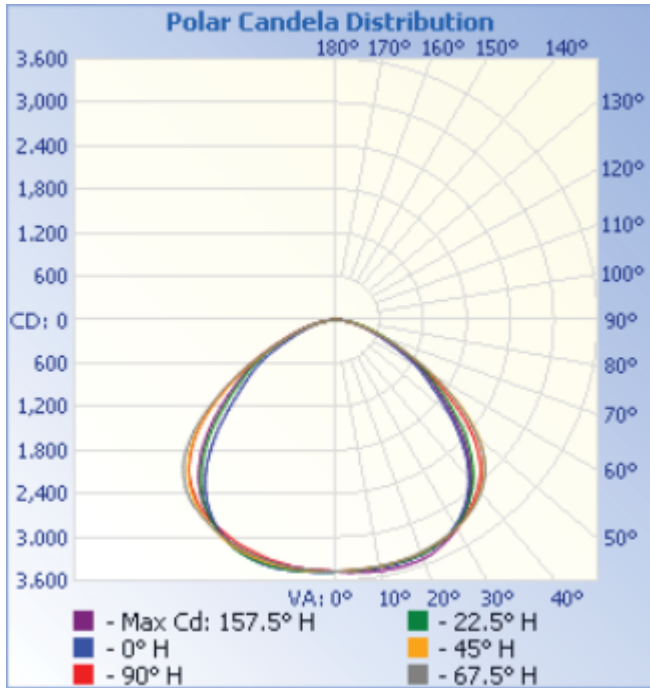

Illuminance at a Distance

	Center Beam fc	Beam Width	
17.0ft	12.01 fc	45.3 ft	51.7 ft
34.0ft	3.00 fc	90.7 ft	103.5 ft
51.0ft	1.33 fc	136.0 ft	155.2 ft
68.0ft	0.75 fc	181.3 ft	206.9 ft
85.0ft	0.48 fc	226.7 ft	258.6 ft
102.0ft	0.33 fc	272.0 ft	310.4 ft

■ Vert. Spread: 106.3°
■ Horiz. Spread: 113.4°

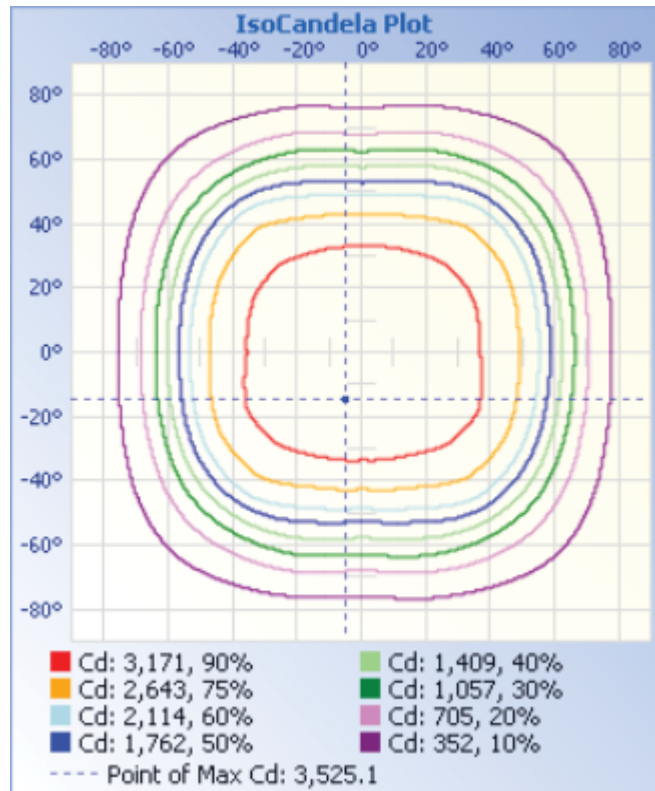
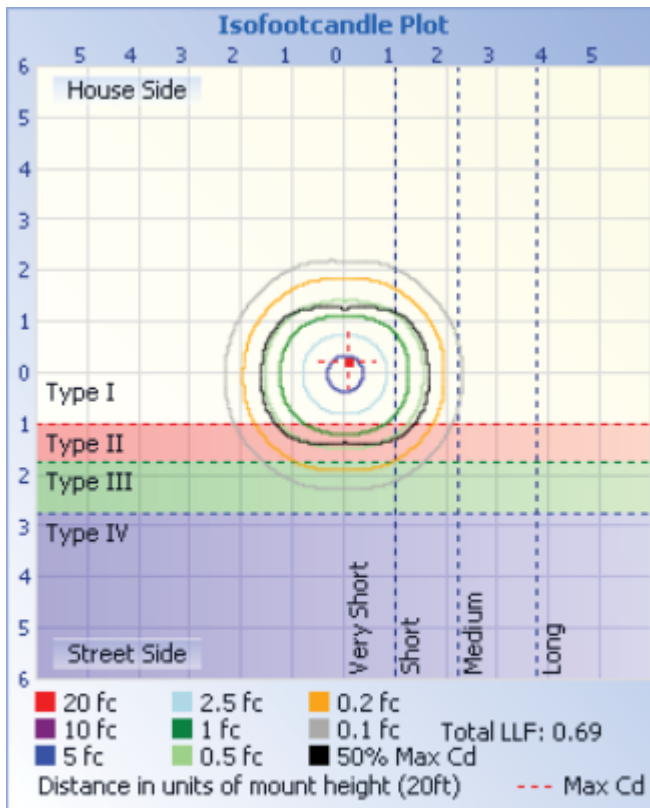

LED FLOOD LIGHT

Photometric Data

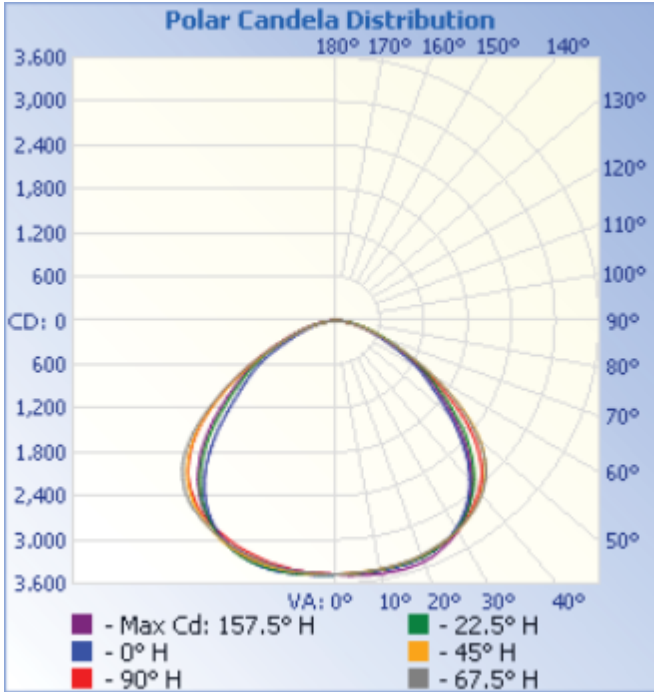

Illuminance at a Distance

	Center Beam fc	Beam Width	
17.0ft	12.01 fc	45.3 ft	51.7 ft
34.0ft	3.00 fc	90.7 ft	103.5 ft
51.0ft	1.33 fc	136.0 ft	155.2 ft
68.0ft	0.75 fc	181.3 ft	206.9 ft
85.0ft	0.48 fc	226.7 ft	258.6 ft
102.0ft	0.33 fc	272.0 ft	310.4 ft

■ Vert. Spread: 106.3°
■ Horiz. Spread: 113.4°

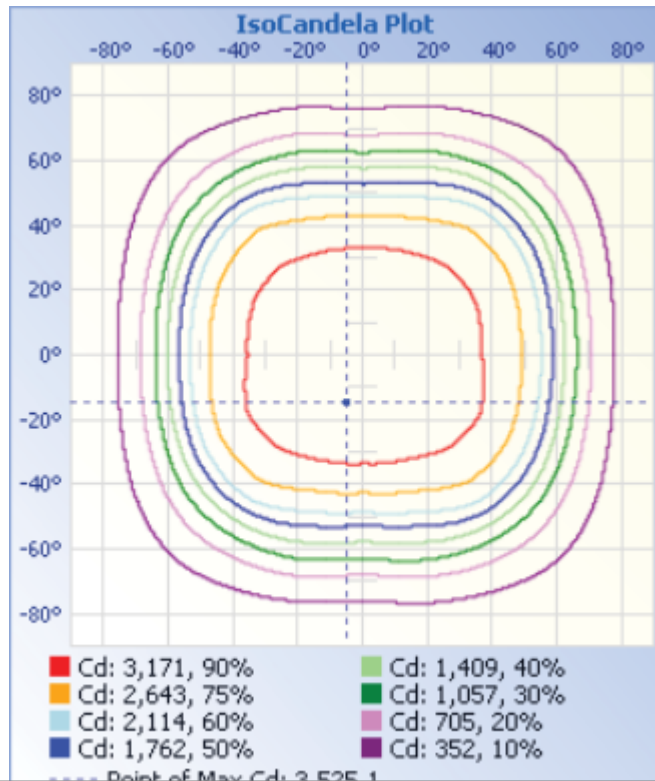
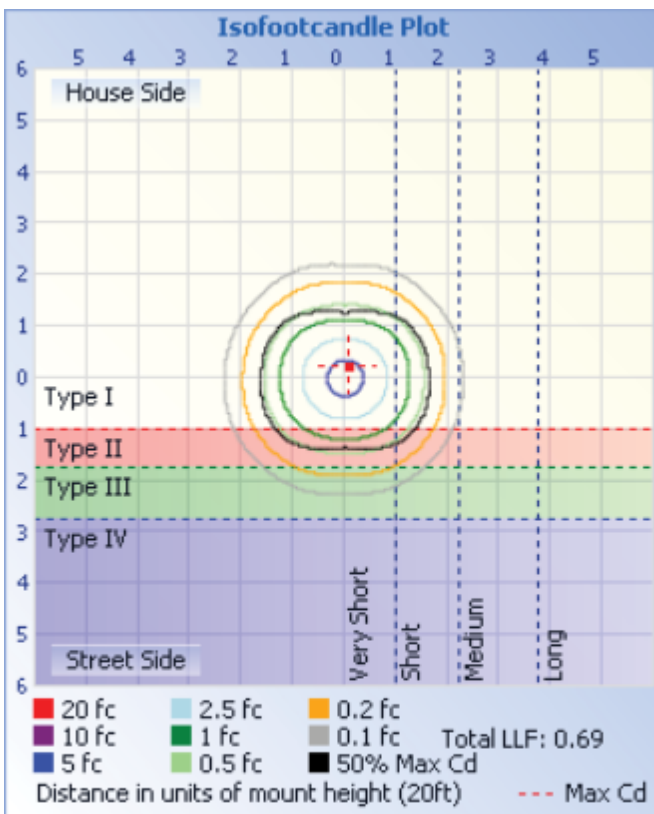

LED FLOOD LIGHT

Installation

Cautions:

1. Do not use the electric generator to test the LED lamp.
2. Please abide by related country, regional and local law and regulations when install this fixture.
3. Please turn off the power before installation or maintenance.
4. Proper grounding is required to ensure safety.

Notice:

1. To avoid possibility of electrical shock or fire, the installation personnel must have professional electric knowledge.
2. Please wear gloves to avoid injury before installation.
3. If any smoke or spark of the wire happened, please turn off the power immediately and notify relevant personnel.

Attention:

1. Please check if there is any damage during shipping. If so, please contact manufacturer timely.
2. Please read the installation instruction carefully to check whether all the accessories are available. After confirmation, install the fixture according to installation steps.

Instruction:

The installation of this led light with different wattage is different. Please refer to the installation instruction correspondingly.

Wiring Diagram:

Here is a step color adjusting and power adjusting controller

This is the photoreceptor

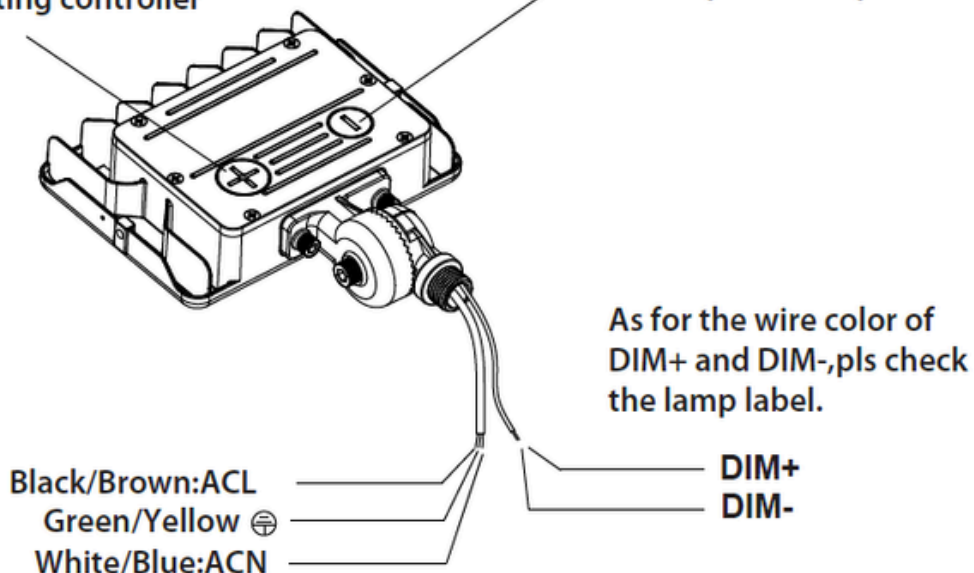

LED FLOOD LIGHT

Installation

1.1 Adjustable tter mounting (b=AM suitable for all power of this series)

Step 1: Take the lamp out of package.

Step 2: pass the wires through hardware and x it with screws. (gure 1.1)

Step 3: Pass the wires through from the other bracket and rubber, x it with screws.
(Watch out not to scratch the wire). (gure 1.2)

Step 4: nished. (gure 1.3)

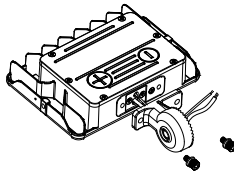

figure 1.1

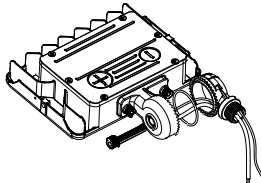

figure 1.2

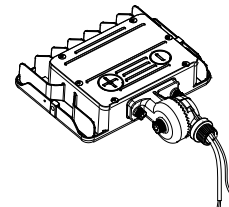

figure 1.3

1.3 Installation of led lamp with adjustable tter (b=AM suitable for all power of this series)

Step 1: Take the lamp out of package.

Step 2: Connect the wires properly according to the right wiring requirements (pay attention to positive wire, negative wire and ground wire) and then put the wires into lamp pole.
(gure 1.4)

Step 3: Loosen the screws, adjust the lamp angles as per actual demands and then tighten the screws.

Tips: Angles of the lamp is adjustable (pass the bracket through mounting surface, x it with screws, then connect the wires as

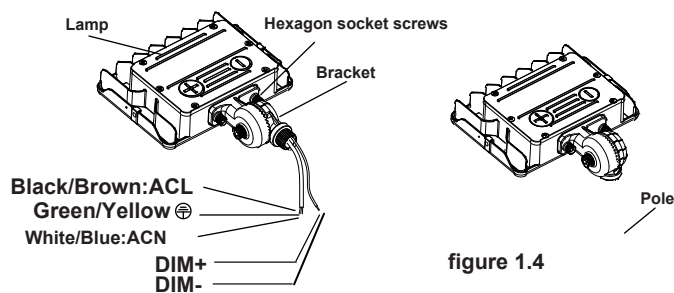

figure 1.4

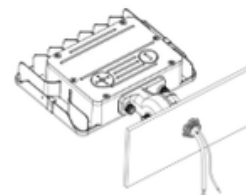

figure 1.5

LED FLOOD LIGHT

Installation

Installation 2: Installation with Yoke Mount

2.1 Yoke Mount installation (b=YM suitable for all power of this series)

Step 1: Take the lamp out of package.

Step 2: Pass the wires through hole of bracket. (figure 2.1)

Step 3: Fix the lamp and bracket together with screws; (Watch out not to scratch the wire)(figure 2.2)

Step 4: Tighten the other bracket with screws (figure 2.3)

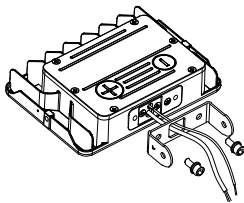

figure 2.1

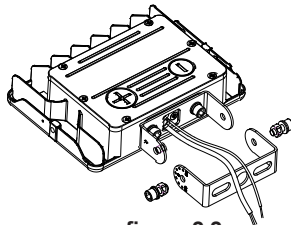

figure 2.2

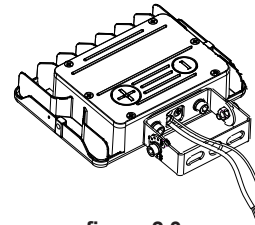

figure 2.3

2.2 Installation of LED lamp with Yoke Mount (b=YM suitable for all power of this series)

Step 1: Take the lamp out of package.

Step 2: Connect the wires properly according to the right wiring requirements (pay attention to positive wire, negative wire, and ground wire) and then put the wires into lamp pole. (figure 2.4)

Step 3: Loosen the screws, adjust the lamp angles as per actual demands and then tighten the screws. (figure 2.5)

Tips: Angles of the lamp is adjustable Led Lamp

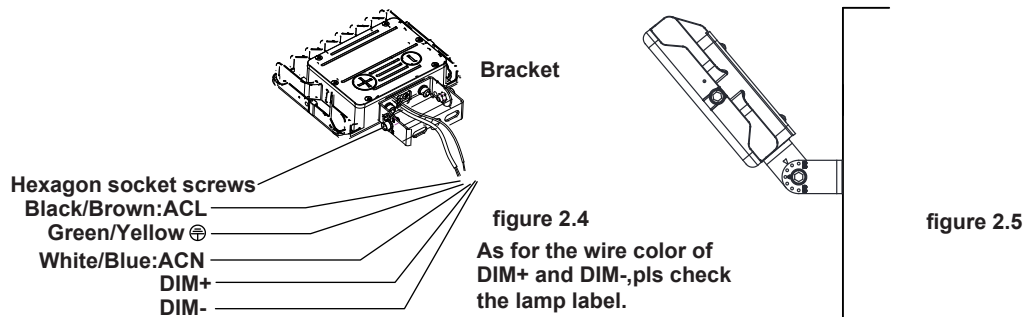

Installation 3: Installation with Flood Mount

3.1 Flood Mount Installation (b=FM suitable for all power of this series)

Step 1: Take the lamp out of package. (figure 3.1)

Step 2: Tighten the brackets and screws. (figure 3.2)

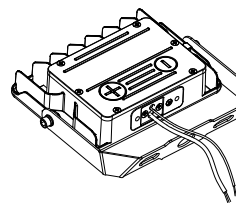
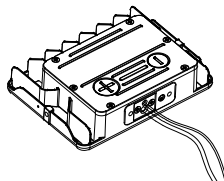

LED FLOOD LIGHT

Installation

3.2 Installation of LED lamp with flood mount (b=FM suitable for all power of this series)

Step 1: Take the lamp out of package.

Step 2: Connect the wires properly according to the right wiring requirements (pay attention to positive wire, negative wire, and ground wire) and then put the wires into lamp pole. (figure 3.3)

Step 3: Loosen the screws, adjust the lamp angles as per actual demands and then tighten the screws. (figure 3.4)

Tips: Angles of the lamp is adjustable Led Lamp

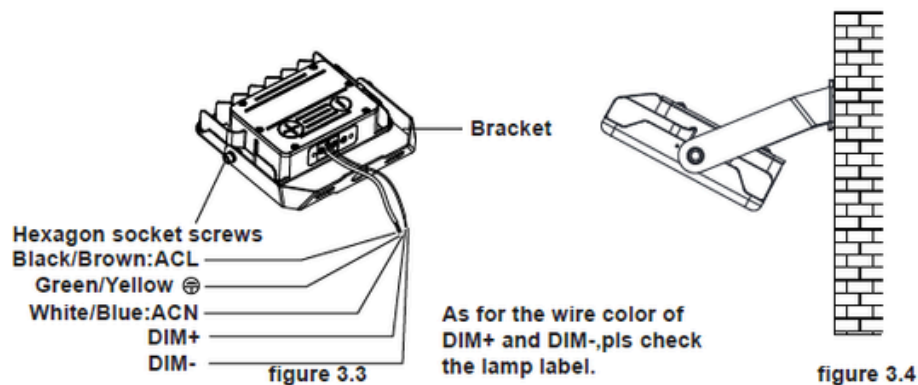

Warning/Avertissement

MIN 75 °C SUPPLY CONDUCTORS.

THIS PRODUCT MUST BE INSTALLED IN ACCORDANCE WITH THE APPLICABLE INSTALLATION CODE BY A PERSON FAMILIAR WITH THE CONSTRUCTION AND OPERATION OF THE PRODUCT AND THE HAZARDS INVOLVED

LES FILS D'ALIMENTATION 75 °C MIN.

CCE PRODUIT DOIT ÊTRE INSTALLÉ SELON LE CODE D'INSTALLATION PERTINENT, PAR UNE PERSONNE QUI CONNAÎT BIEN LE PRODUIT ET SON FONCTIONNEMENT AINSI QUE LES RISQUES INHÉRENTS

LED FLOOD LIGHT

Notice For User

- Please turn o power before install or change assembly parts.
- The input voltage and lamps should be matched, after connecting the power line, Please make sure the wiring section is insulated.
- No-professionals, must not install and disassemble the lamps.

TROUBLE SHOOTINGS

TROUBLES	CHECK POINTS
Flickering of the light	Turn o the power and turn on again in 3 minutes. If same phenomena occur, then call agencies.
Out of working	Please check the connection.

Packaging

SKU	Box Type	Box Dimensions	Qty	Net Weight	Gross Weight
156786	Inner Box				
	Outer Box	19.17" X 11.81" X 12.20"	8 PCS/Box	19.40LBS	24.91LBS
156254	Inner Box	10.82" X 2.95" X 12.20"	1 PC/Box	3.30LBS	3.96LBS
	Outer Box	18.54" X 12.80" X11.61"	6 PCS/Box	19.84LBS	25.35LBS

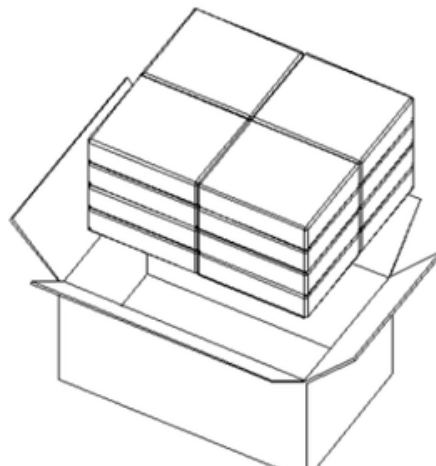

LED FLOOD LIGHT

Application

