

LED GRID PANEL

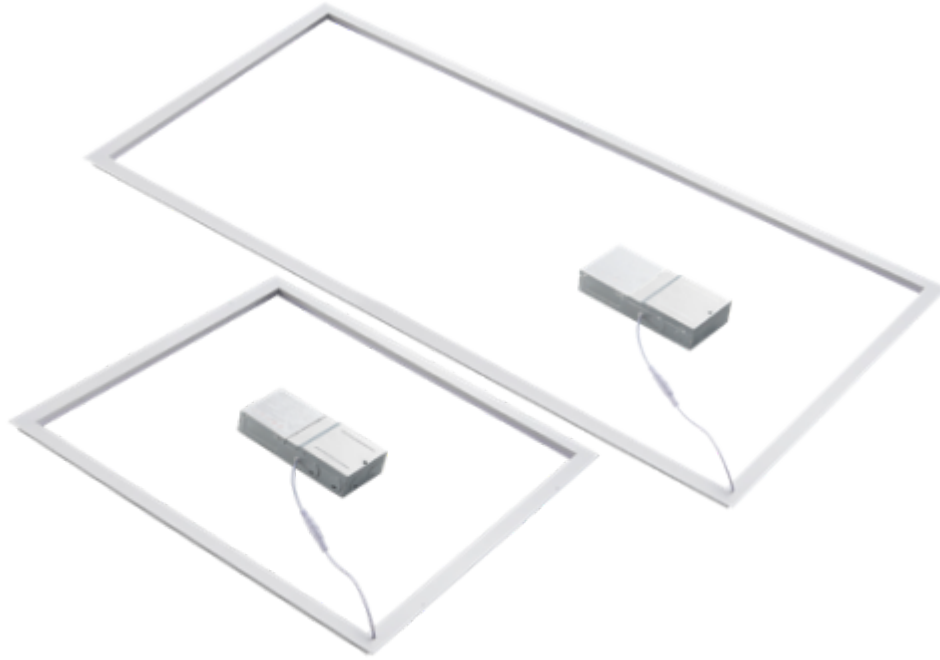

Lumens Depot Foam's LED Geometric Grid Panels are designed to deliver uniform illumination with exceptional energy efficiency, making them a modern upgrade from traditional T5, T8, or T12 fluorescent troffers. Featuring a high-quality diffusing lens, they ensure bright, even light distribution for enhanced comfort and visibility. With adjustable wattage and selectable CCT options, these panels provide the flexibility to meet diverse lighting requirements across various applications. Their contemporary geometric design integrates seamlessly with architectural ceilings, creating a clean, elegant, and modern lighting effect.

Ideal for corporate offices, healthcare facilities, educational institutions, and other commercial environments, these panels offer a perfect balance of style and performance. The ultra-lightweight construction allows for easy installation while ensuring long-lasting durability and reliable operation.

Product Features

- Upto120 lm/W
- Available in 2x2 & 2x4
- Adjustable wattage
- Adjustable CCT
- 0-10V Dimmable
- 120° Beam Angle
- White Housing
- Input Voltage 100-277VAC
- ETL & DLC listed
- 5-year warranty

LED GRID PANEL

ADJ. WATT	MAX LUMENS	ADJ. CCT	INPUT VOLTAGE	CRI	SIZE	LIGHT SPREAD	CONSTRUCTION	DIMMING	CERTIFICATIONS
20W/30W/40W	5000	3K/3500K/4K/5K/6500K	100-277V	>80	2x2	120°	Aluminum+PC	0-10V	ETL & DLC
40W/50W/60W	7500	3K/3500K/4K/5K/6500K	100-277V	>80	2x4	120°	Aluminum+PC	0-10V	ETL & DLC

Specifications

Parameter	Description	Value
General Performance	Model #	BLT-FL2*2-K40-3065
	Adjustable Watt	20W / 30W / 40W
	Max Lumen	5000
	Lumen Efficacy	Up to 120LM/W
	Color Temperature	3000K / 3500K / 4000K / 5000K / 6500K
	CRI (Ra)	>80
	Light Spread	120°
	Diffuser Type	PC Cover
Electrical	Input Voltage	100-277Vac
	Frequency	50/60Hz
	Dimming	0-10V
	THD	<10%
	Power Factor	>0.9
	Flicker Percent	N/A
Physical	Operating Temperature	25oC to 2oC
	Operating Humidity	65% RH
	Storage Temperature	-20oC to 45oC
	Storage Humidity	N/A
	LED Brand	N/A
	LED Type	2835
	LED QTY	N/A
	Construction	PC+Aluminum
Qualification	Housing Color	White
	IP Rating	IP20
	Warranty	5 Years

LED GRID PANEL

Specifications

Parameter	Description	Value
General Performance	Model #	BLT-FL2*4-K60-3065
	Adjustable Watt	40W / 50W / 60W
	Max Lumen	7500
	Lumen Efficacy	Up to 120LM/W
	Color Temperature	3000K / 3500K / 4000K / 5000K / 6500K
	CRI (Ra)	>80
	Light Spread	120°
	Diffuser Type	PC Cover
Electrical	Input Voltage	100-277Vac
	Frequency	50/60Hz
	Dimming	0-10V
	THD	<10%
	Power Factor	>0.9
	Flicker Percent	N/A
Physical	Operating Temperature	25oC to 2oC
	Operating Humidity	65% RH
	Storage Temperature	-20°C To 45°C
	Storage Humidity	N/A
	LED Brand	N/A
	LED Type	2835
	LED QTY	N/A
Construction	PC+Aluminum	
Qualification	Housing Color	White
	IP Rating	IP20
	Warranty	5 Years

LED GRID PANEL

Correlated Color Temperature (CCT)

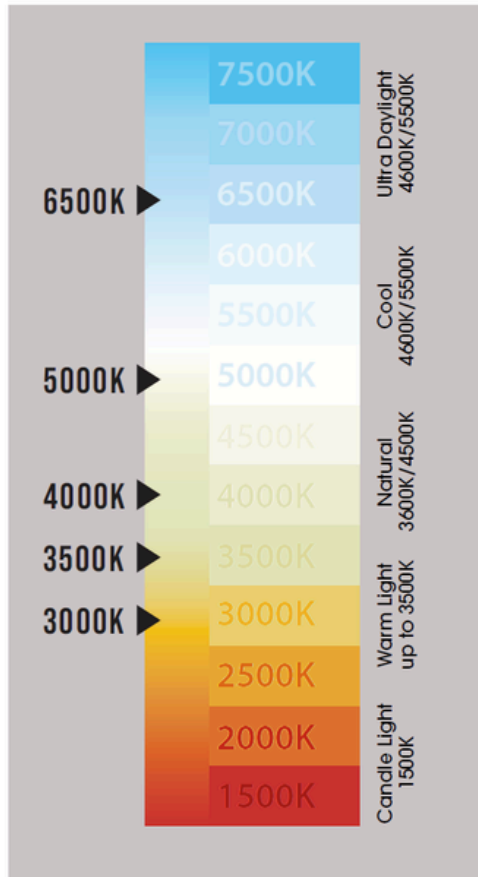

Dimensions

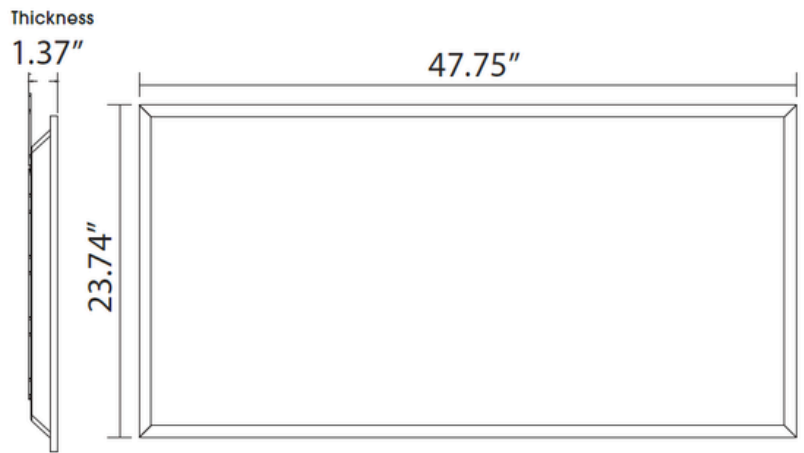
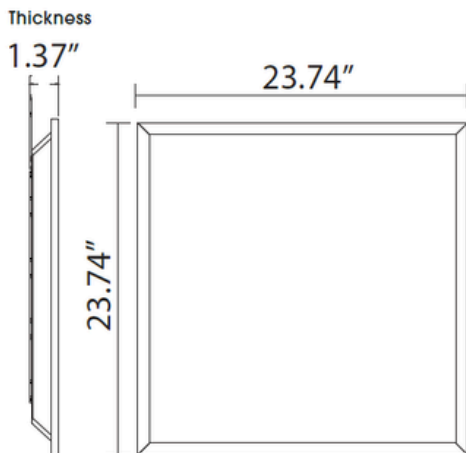

LED GRID PANEL

Polar Curve of 3000K

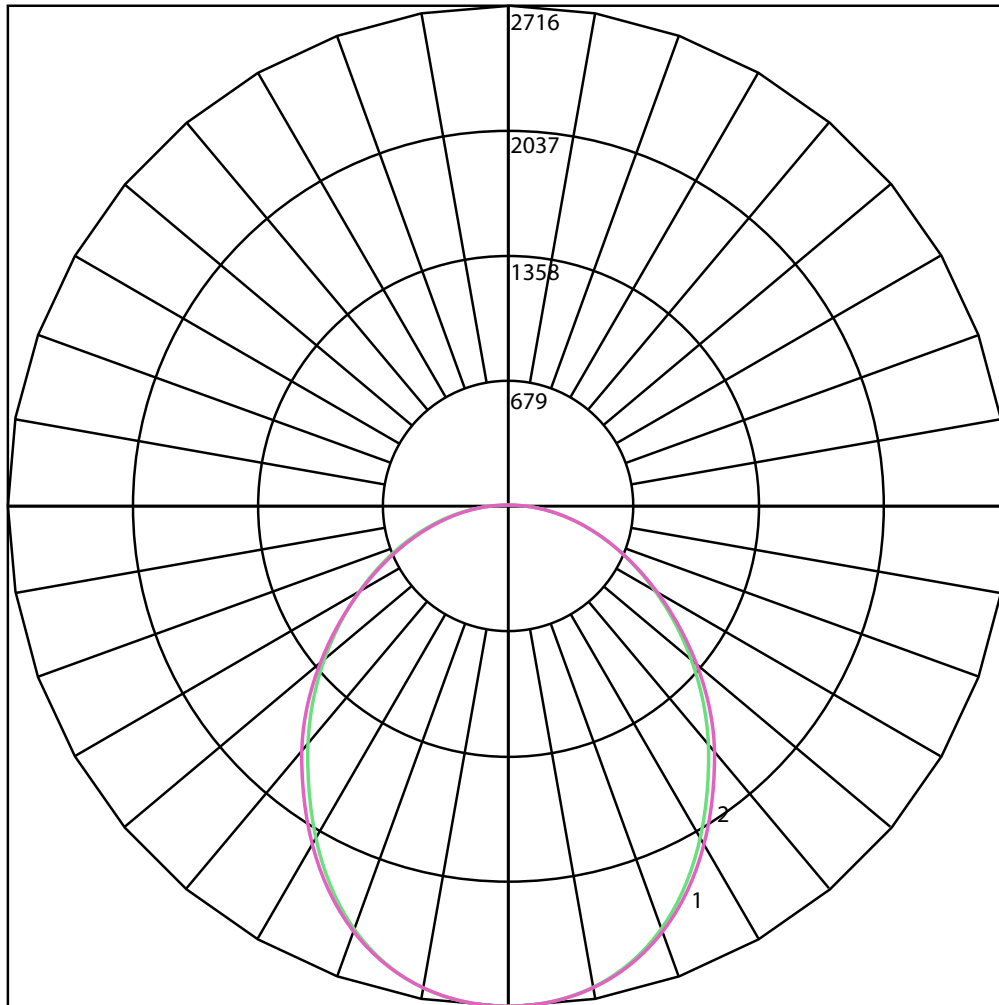

Maximum Candela = 2715.561 Located At Horizontal Angle = 0, Vertical Angle = 0

#1 - Vertical Plane Through Horizontal Angles (0 - 180)

#2 - Vertical Plane Through Horizontal Angles (90 - 270)

LED GRID PANEL

Installation

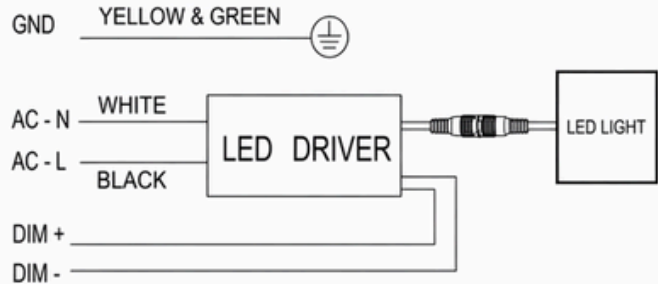
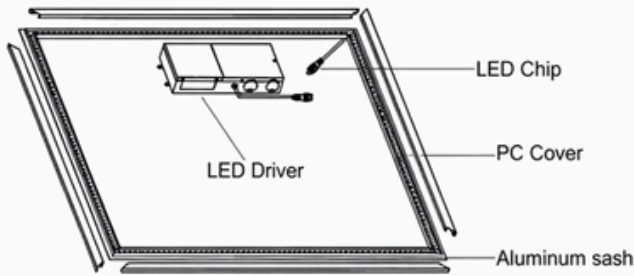

INSTALLATION INSTRUCTION

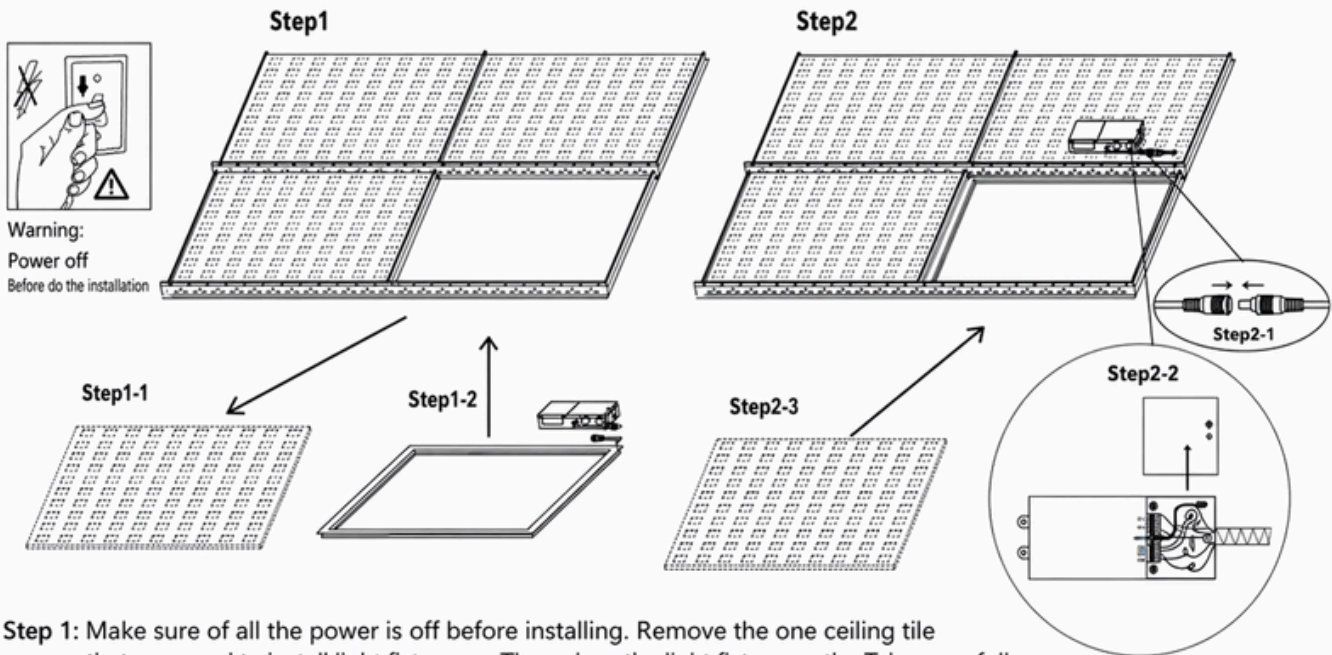

Step 1: Make sure of all the power is off before installing. Remove the one ceiling tile that you need to install light fixture on. Then place the light fixture on the T-bar carefully and make sure it is correctly in place and secure.

Step 2: Place the driver on top of the next ceiling tile. Connect the cable between the driver and the lighting fixture.

Step 3: Open the driver's junction box and connect the AC wire to the driver correctly (L=black & N=white)

Warning:

Ensure the power supply has been cut off before connecting the wire, and all wiring and installation of this product are required to be operated by professionals.

LED GRID PANEL

Packaging

Box Dimension	Size	Qty	Net Weight	Gross Weight
49.21" x 5.51" x 25.19"	2 x 4	4 PCS/Box	11LBS	15.5LBS
25.20" x 5.51" x 25.20"	2 x 2	4 PCS/Box	8.8LBS	10.2LBS

Application Images



LED GRID PANEL

Application Images

