

LED CENTER BASKET TROFFERS



Lumens Depot Foam's Architectural Recessed Troffer offers a clean, modern design with a fully luminous door-frame structure, delivering both style and performance. This contemporary, high-quality luminaire is engineered to provide superior visual comfort while utilizing advanced solid-state lighting and driver technology for optimal efficiency.

Available in 2x2' and 2x4' sizes, it brings sleek design and clear, uniform illumination to a variety of spaces. Ideal for commercial settings, hospitality environments, offices, and restaurants, this fixture combines aesthetic appeal with reliable, energy-efficient lighting performance.

Product Features

- Up to 110 Lumens per watt
- Architectural quality design and construction
- Fully luminous center panel
- CCT Adjustable 3500K / 4000K / 5000K
- Wattage Adjustable
- 1-10 Dimming
- Available in 2x2' & 2x4'
- Beam Angle 120° Degree
- Suitable for all standard 2x2' & 2x4' grid ceilings
- Optional hanging mount & Surface mounting kit
- Input Voltage 100-277Vac 50-60Hz
- UL Listed
- 5 Years warranty

LED CENTER BASKET TROFFERS

Wattage Adjustable	Lumens	CCT Adjustable	Length	Housing	Input Voltage	Certifications
25W/30W/35W	3850Lm	3500K/4K/5K	2x2'	White	100V-277V	UL
30W/40W/50W	5500Lm	3500K/4K/5K	2x4'	White	100V-277V	UL

Specifications

Parameter	Description	Value
General Performance	Model #	BLT-TR22-DM-TWTS
	Wattage Adjustable	25W / 30W / 35W
	Lumen	3850Lm
	Lumen Efficacy	Up to 110LM/W
	Color Temperature	3500K/4000K/5000K
	CRI (Ra)	>80
	Beam Angle	110o Degree
	Diffuser Type	PS
Electrical	Input Voltage	110-277Vac
	Frequency	50/60Hz
	Dimming	1-10V
	Power Factor	>0.9
	Operating Temperature	-20oC - 40oC
Physical	Operating Humidity	<50%
	Storage Temperature	25oC - 1oC
	Storage Humidity	<50%
	LED Brand	HWX
	LED Type	SMD2835
	Housing	Aluminum
	Housing Color	White
Qualification	IP Rating	IP40
	Warranty	5 Years warranty

LED CENTER BASKET TROFFERS

Specifications

Parameter	Description	Value
General Performance	Model #	BLT-TR24-DM-TWTS
	Wattage Adjustable	30W / 40W / 50W
	Lumen	5500Lm
	Lumen Efficacy	Up to 110LM/W
	Color Temperature	3500K/4000K/5000K
	CRI (Ra)	>80
	Beam Angle	110° Degree
Electrical	Diffuser Type	PS
	Input Voltage	110-277Vac
	Frequency	50/60Hz
	Dimming	1-10V
	Power Factor	>0.9
Physical	Operating Temperature	-20°C - 40°C
	Operating Humidity	<50%
	Storage Temperature	25°C - 1°C
	Storage Humidity	<50%
	LED Brand	HWX
	LED Type	SMD2835
Qualification	Housing	Aluminum
	Housing Color	White
	IP Rating	IP40
	Warranty	5 Years warranty

LED CENTER BASKET TROFFERS

Correlated Color Temperature (CCT)

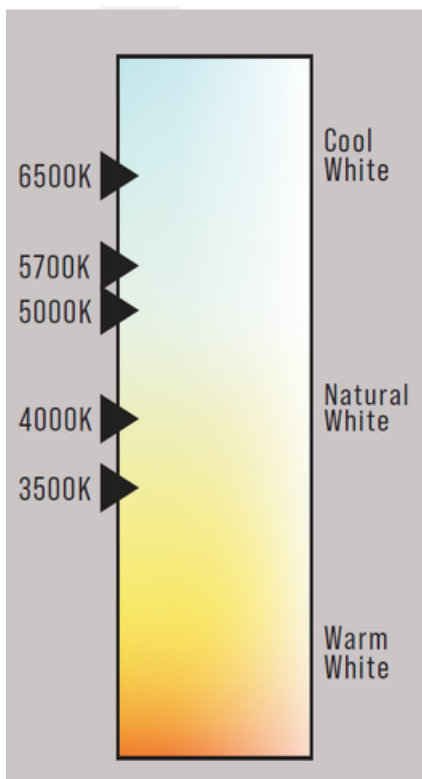

Dimension

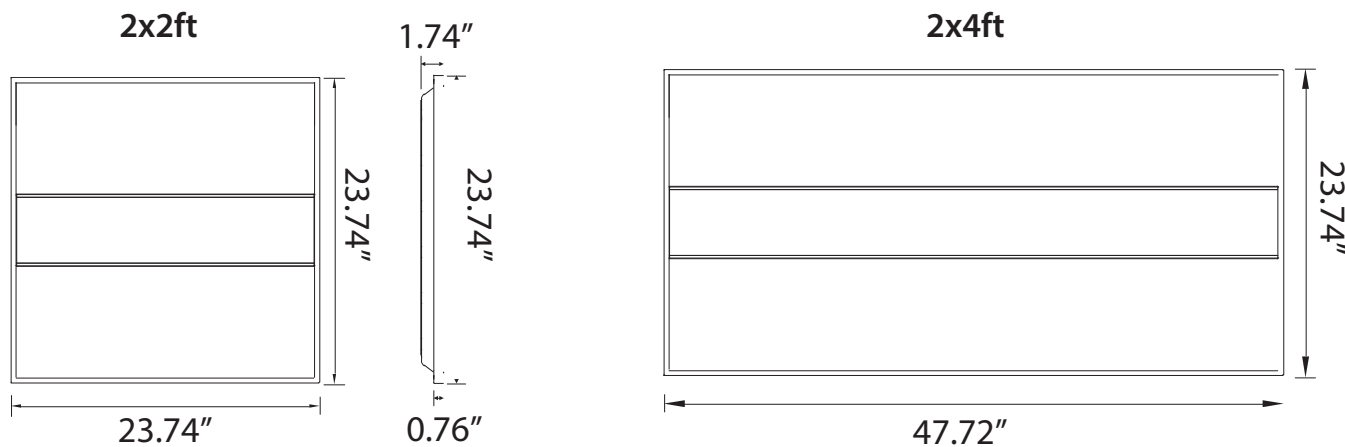

LED CENTER BASKET TROFFERS

Distribution Diagram

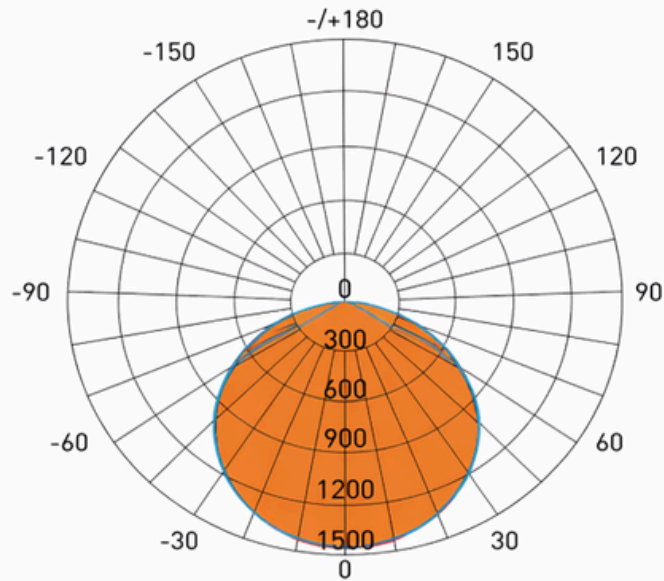

AVERAGE BEAM ANGLE(50%): 111.1°

Test Number: TR22-DM-TWTS

Lumens: 4000.66 Lm

Watts: 35 W

LPW: 116.73 Lm/W

CCT: 3500K

UNIT: cd

— C0/180,110.7°

— C30/270,110.2°

— C60/240,111.1°

— C90/270,112.5°

Distribution Diagram

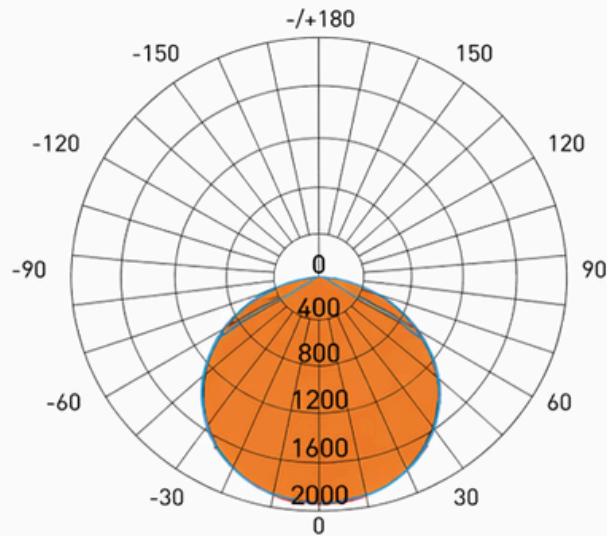

AVERAGE BEAM ANGLE(50%): 111.7°

Test Number: TR24-DM-TWTS

Lumens: 5575.0 Lm

Watts: 50 W

LPW: 113.55 Lm/W

CCT: 3500K

UNIT: cd

— C0/180,111.1°

— C30/270,110.0°

— C60/240,112.0°

— C90/270,113.5°

LED CENTER BASKET TROFFERS

Photometric Data

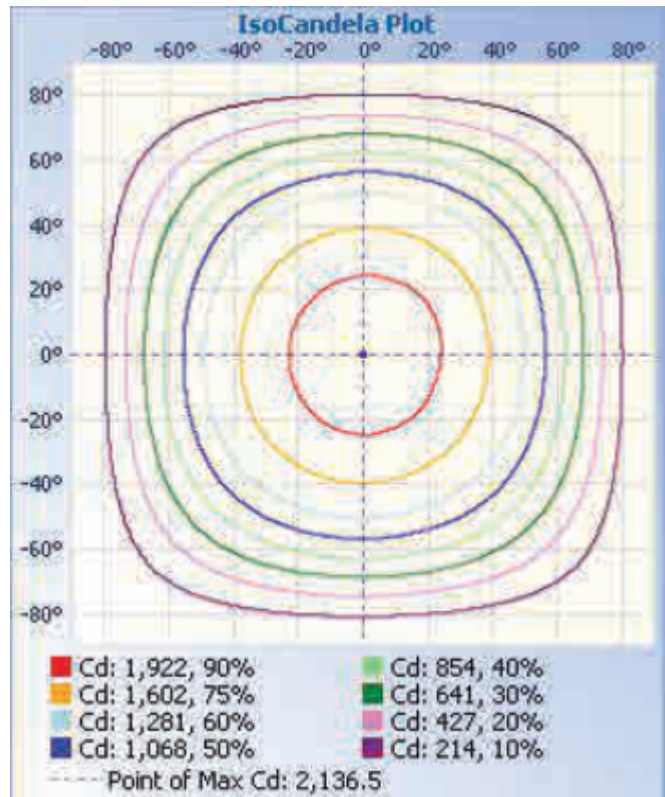
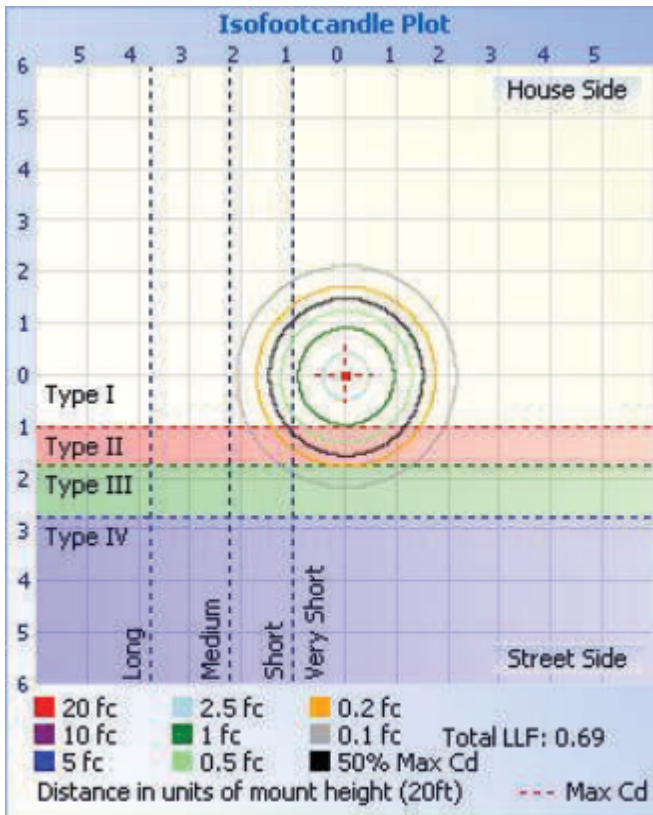
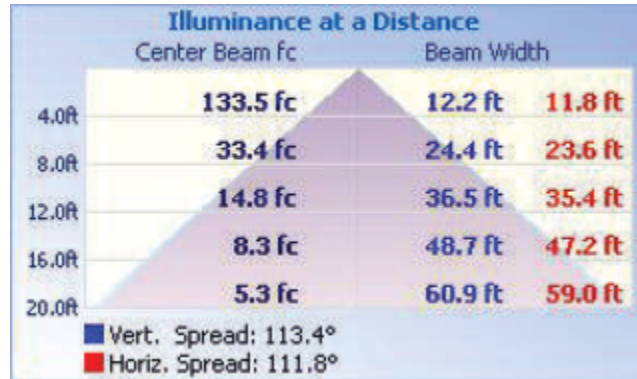
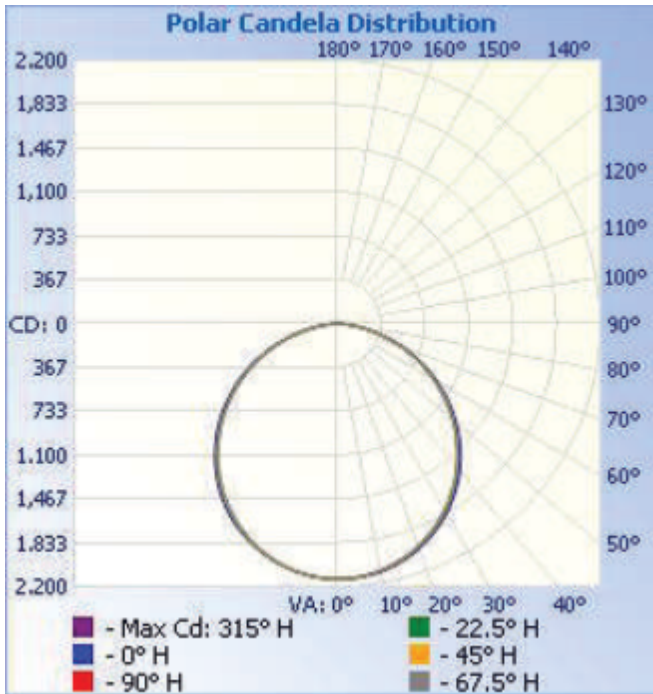

LED CENTER BASKET TROFFERS

Installation (OPTIONAL) 2' X 2' & 2' X 4'

NOTE

Please read this entire manual to fully understand and safely use this product.

Specifications are subject to change without notice.

Please visit our website the most recent user guide versions.

UNPACKING

1. Unpack and carefully examine the product
2. Report any damage and save all packing materials if any part(s) were damaged during shipping.
3. Do not attempt to use this apparatus if it is damaged.

IMPORTANT SAFETY INFORMATION



CAUTION: Risk of Electric Shock

Suitable for Damp location. Access above ceiling required. Suitable for suspended ceilings

READ ALL INSTRUCTIONS BEFORE INSTALLATION

1. Consult a qualified electrician to ensure correct branch circuit conductor.
2. The product should be installed and operated by a qualified electrician or technician in accordance with relevant local codes.
3. Risk of electric shock. Ensure that main power source is off when wiring or soldering the sections of the product.
4. Before installing this fixture or doing any maintenance, make sure to turn off the power supply at the circuit breaker or fuse box.
5. Check to make sure that all fixture connections have been properly made and the fixture is grounded to avoid potential electrical shocks.
6. Designed for use in AC100-277V, 50/60Hz, protected circuit.

INCLUDED IN THIS BOX

1. LED Luminaire
2. Installation Instruction

LED CENTER BASKET TROFFERS

Installation

Step 1

Bend J-Hook by 45° making it vertical to the rear cover of LED luminaire (Figure 1A).

Bend the top part of J-Hook by 90° (Figure 1 B). Repeat STEP1 to other J-Hooks.

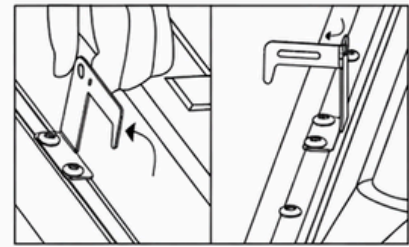

Figure 1 A

Figure 1 B

Step 2

Turn off power, remove the ceiling panel, then place LED luminaire into the T-bar, ensure the LED luminaire is attached to the ceiling. (Figure2) (J-Hook for positioning only)

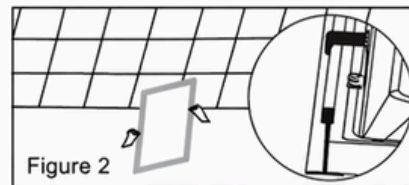

Figure 2

Step 3

Open the driver box. (Figure 3) (trade size of conduit: 22.2mm dia)

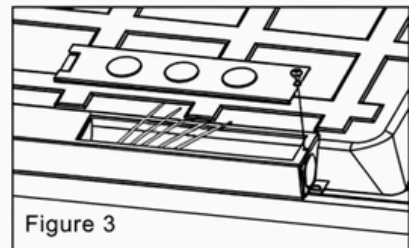

Figure 3

Step 4

Connect AC Wires

1. Input L connects to the black wire of the luminaire, N connects to the white wire, the ground connects to the green wire.

2. Connect Dimmer

Compatible with 0-10V dimmer

The driver VIOLET (D+) to the dimmer+ and the driver PINK(D-) to the dimmer-

Connect the wires with terminal cap as shown in wiring diagram. (Figure 4)

Incoming insulated dimming conductors shall have voltage rated at least equal to the branch voltage.

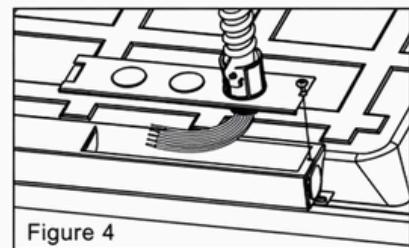

Figure 4

Step 5

Close the driver box and screw in (Figure 5)

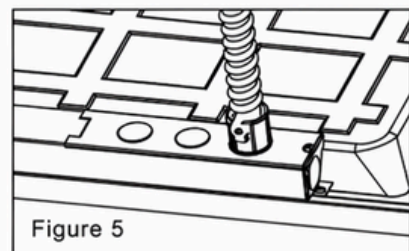
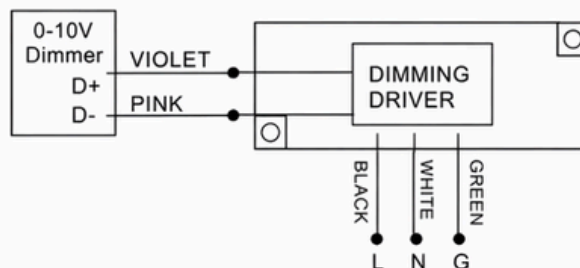

Figure 5

WIRING DIAGRAM



LED CENTER BASKET TROFFERS

Packaging

Size	L x W x H	Net Weight (LBS)	Gross Weight (LBS)
2' x 2'	25.59 x 9.65 x 25.59	20.28	24.69
2' x 4'	49.61 x 9.65 x 25.59	39.24	45.11

LED CENTER BASKET TROFFERS

Application Picture

